

FEATURES

MODEL	HB100062SS24300			
TYPE	Gas Booster - Single Acting			
	Single Stage - Double Air Drive			
RATING	10,000 psi	-	689	Bar
MAX OUTLET PRESSURE (pB)	11,095 psi	-	765	Bar
TRANSMISSION RATIO (i)	1:76			

TECHNICAL

COMPRESSION RATIO	1:15				
DISPLACEMENT CYCLE	1.47	in ³	-	24.1	cm ³
MAX PUMPING SPEED	100	cpm			
MAX OP. TEMPERATURE	212	°F	-	100	°C

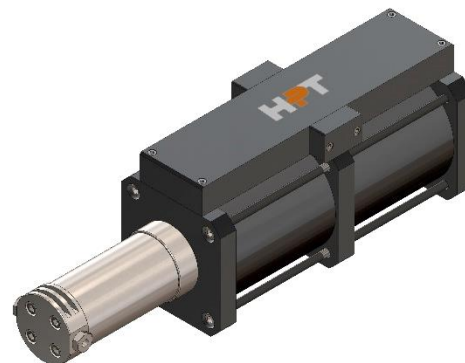

PERFORMANCES

MAX DRIVE PRESSURE (pL)	145	psi	-	10	Bar	
AIR CONSUPTION	65.2	scfm	-	1,847	NI/min	(pL 145 psi - 10 Bar, 50 cpm)
OUTLET FLOW	4.3	scfm	-	121	NI/min	(pA 1450 psi - 100 Bar, 50 cpm)
MIN INLET PRESSURE (pA)	740	psi	-	51	Bar	(to reach pB)
MAX INLET PRESSURE (pA)	10,000	psi	-	689	Bar	
STALL PRESSURE	i * pL					

CONNECTIONS

INLET	1/4" BSPP (F)	DRIVE RELIEF VALVE	3/8" BSPP (F)
OUTLET	1/4" BSPP (F)	EXT. PILOT SUPPLY	1/8" BSPP (F)
DRIVE INLET	1/2" BSPP (F)	PULSE COUNTER	1/8" BSPP (F)

INFORMATIONS

LENGHT	24.0	in	-	610	mm	(approx.)
WIDTH	6.3	in	-	160	mm	(approx.)
HEIGHT	7.9	in	-	200	mm	(approx.)
NET WEIGHT	40.8	lb	-	18.5	Kg	(approx.)

ALL PICTURES SHOWN ARE FOR ILLUSTRATION PURPOSE ONLY. ACTUAL PRODUCT MAY VARY DUE TO PRODUCT ENHANCEMENT.